

One Love

By Kaela Ross, age 10

New guidelines
by Stephen Weiss.

Lets get together now and be alright.



1

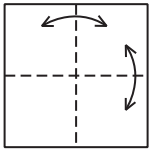

Valley-fold in half both ways and unfold.

2

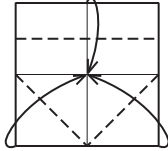

Valley fold the top edge and two corners to the center.

3

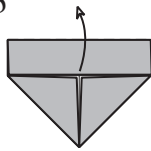

Unfold the flap.

4

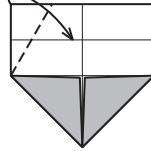

Valley-fold to the corner to the crease line.

5

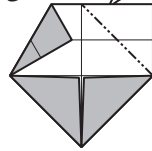

Mountain-fold.

6

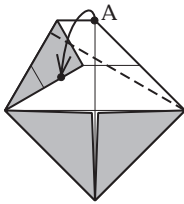

Valley-fold point A to the indicated edge.

7

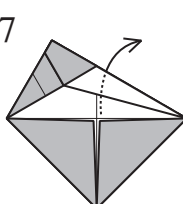

Unfold the back flap.

8

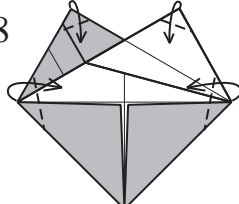

Valley-fold the four corners to taste.

9

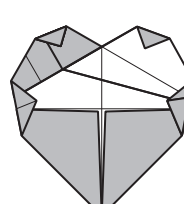

Turn over.

10

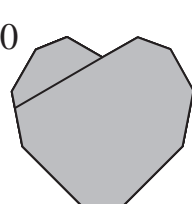

The heart is one.

Two Love

By Stephen Weiss
inspired by Kaela's
one love.

Kaela's One Love times two makes Two Love. You might even be able to fool people into thinking that there are two dollars here, and if they catch you, you can simply say, "Well, what I meant, is it's worth two dollars. I mean, it's actually worth ten dollars, but I'm giving you a special deal!"



1

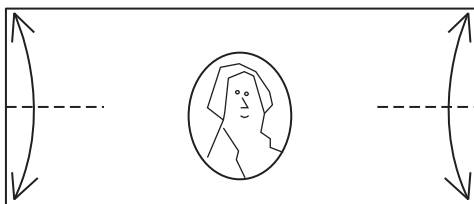

Begin with a Dollar face up. Valley-fold in half but only pinch at the sides.

2

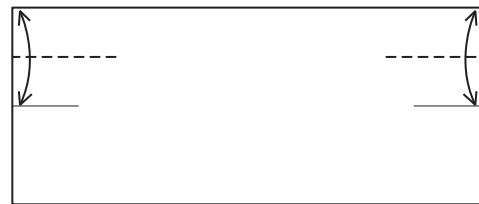

Valley-fold to the pinch marks made in step 1. The valley fold does not need to extend across the dollar.

3

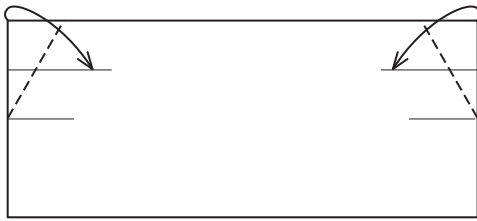

Valley-fold the corners to the creases made in step 2. The folds hit the half marks on the side.

4

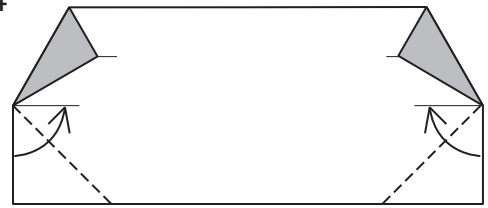

Valley-fold edge-to-crease.

5

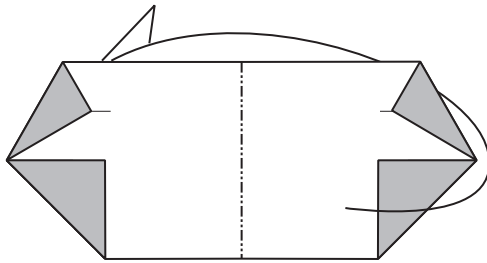

Mountain-fold the model in half.

6

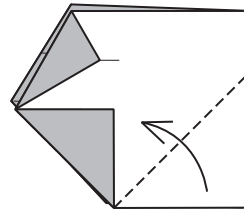

Valley-fold.

7

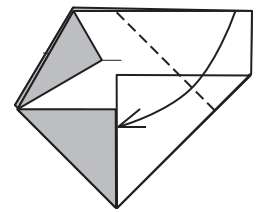

Valley-fold.

8

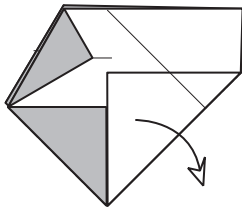

Unfold.

9

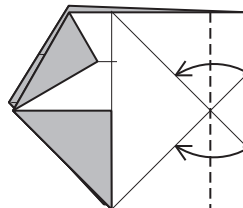

Valley-fold through the intersection of the existing creases.

10

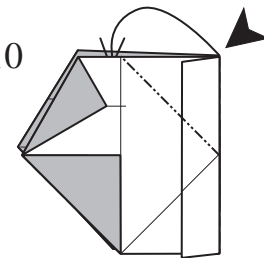

Reverse-fold on the existing crease.

11

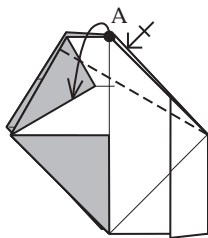

Valley-fold. Repeat behind.

12

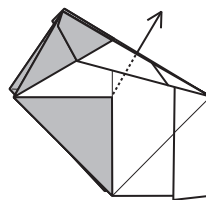

Pull out the interior flap.

13

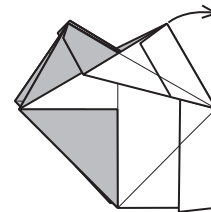

Pull the flap out.

14

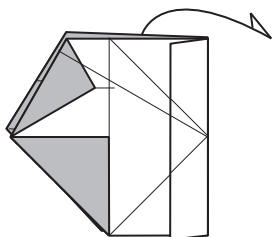

Swing the rear flap out to the right side.

15

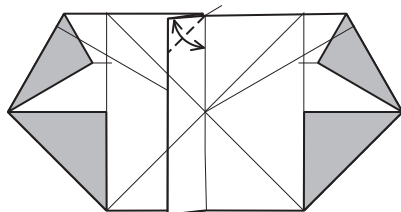

Valley-fold and unfold.

16

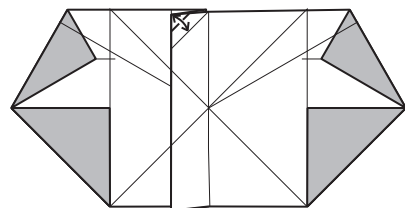

Valley-fold and unfold.

17

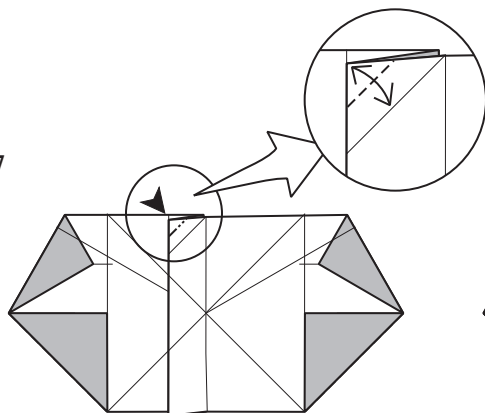

Reverse-fold the tip.

18

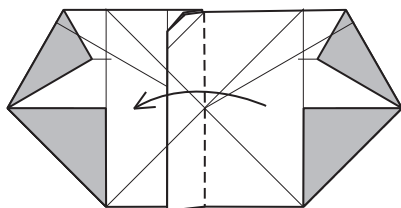

Valley-fold the right flap to the left

19

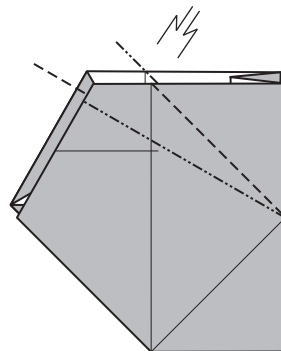

Crimp on existing creases, the same creases that were unfolded in step 14.

20

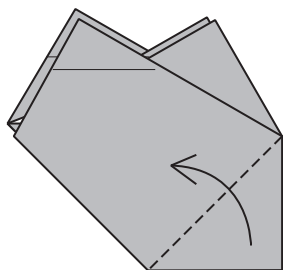

Valley-fold.

21

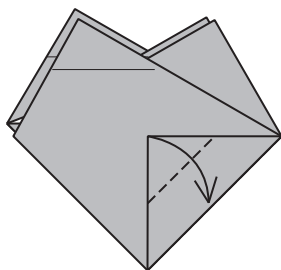

Valley-fold.

22

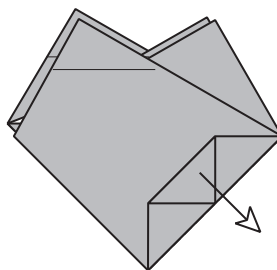

Unfold the pleated flap.

23

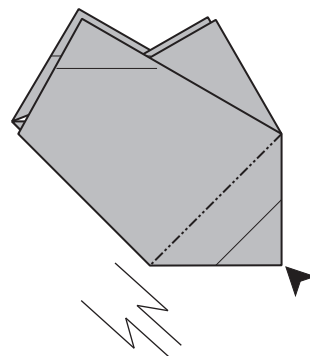

Reverse-fold.

24

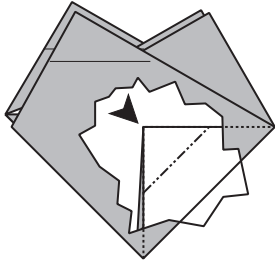

Tear-away view. Reverse-fold the interior corner.

25

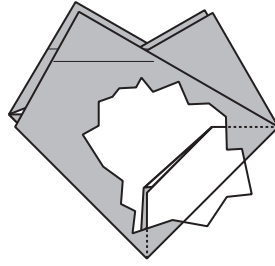

Like this.

26

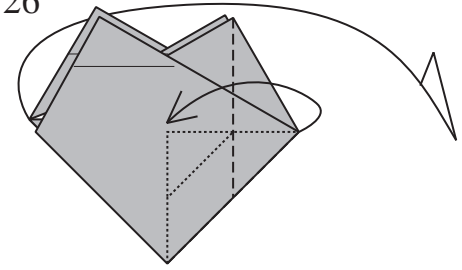

Valley-fold letting the rear flap swing to the right.

27

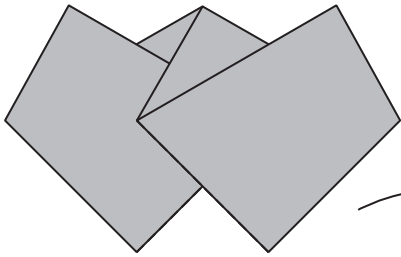

Turn over.

28

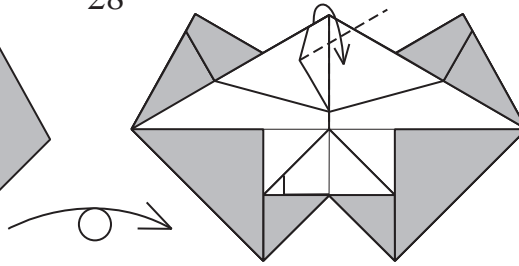

Valley-fold on the front layer.

29

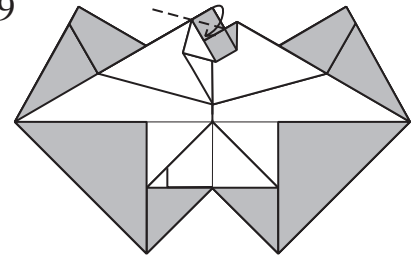

Valley-fold.

30

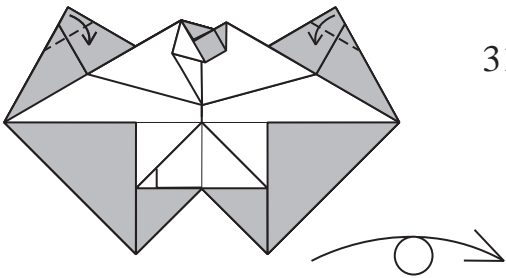

Valley-fold. Turn over.

31

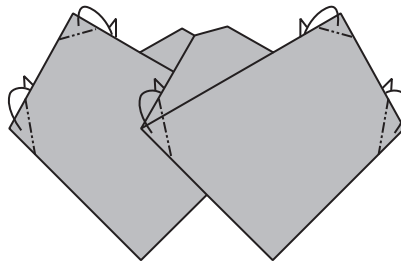

Round out the hearts with mountain folds.

32

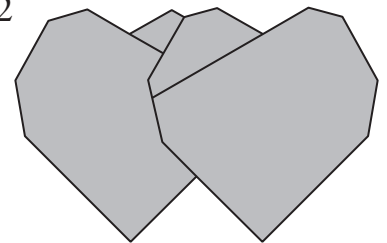

The Two Love, is Twuely finished, ready to stay side-by-side till unfolded by some loveless capitalist.