

Jack-O-Lantern

By Jeremy Shafer ©2000

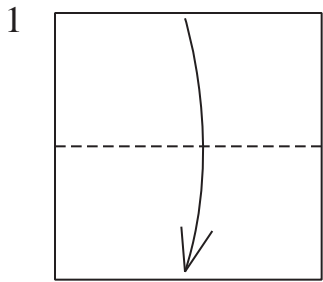

Welcome to Pure Land, home of the mountains and valleys. Valley-fold in half, top to bottom.

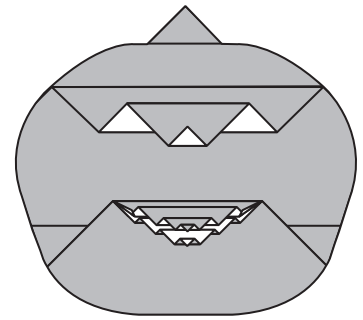
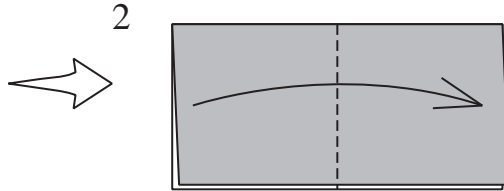

Valley-fold in half, left to right.

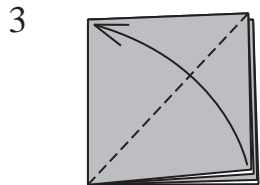

Valley-fold up one flap, preferably the top one.

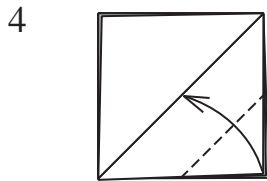

Valley-fold to the center. Exactly where is the center? Get used to it. This model is full of unguided folds.

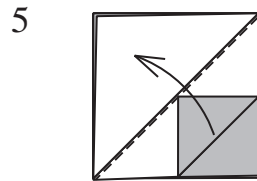

Valley-fold.

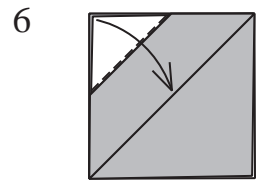

Valley-fold.

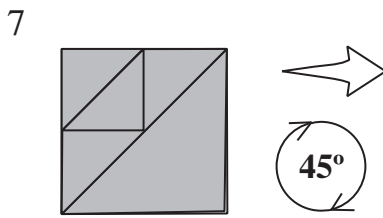

Turn the model (or yourself) 45° and take a closer look at the model.

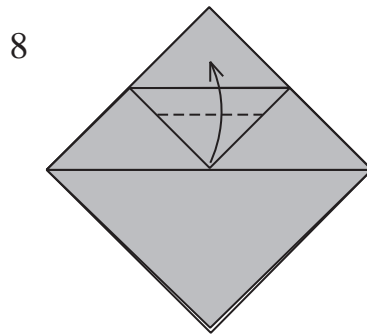

Valley-fold.

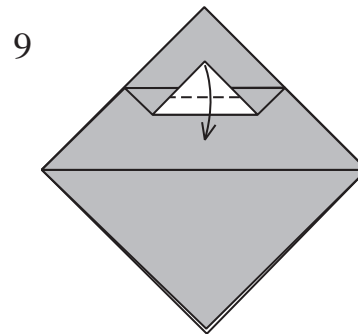

Valley-fold.

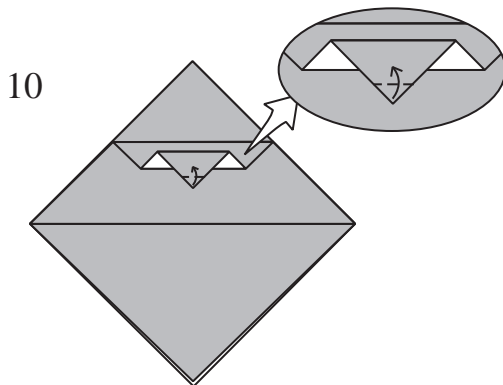

Valley-fold.

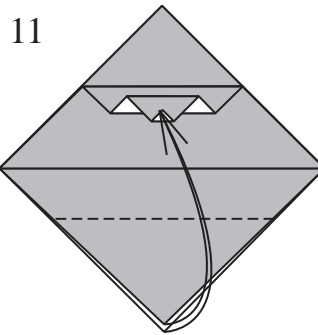

Valley-fold both flaps together.

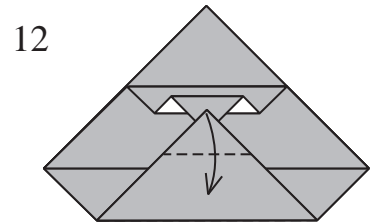

Valley-fold both flaps together.

13

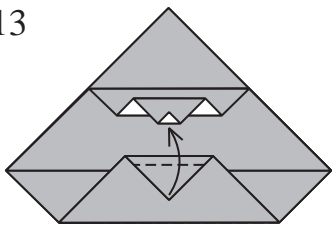

Valley-fold one flap up.

14

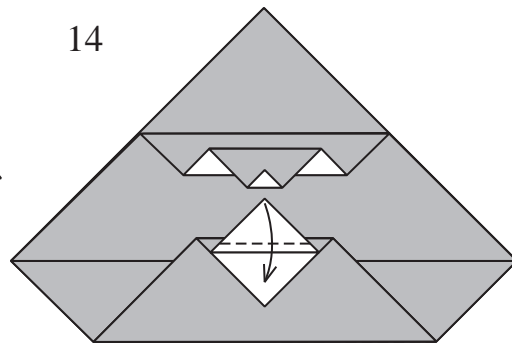

Valley-fold.

15

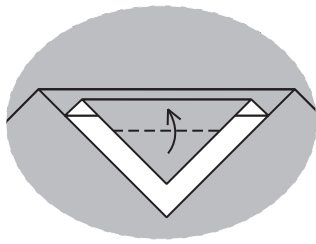

Valley-fold.

16

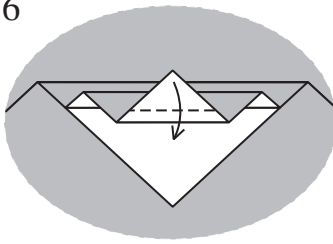

Valley-fold.

17

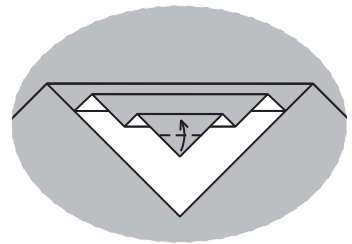

Valley-fold.

18

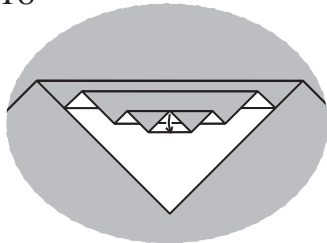

Valley-fold.

19

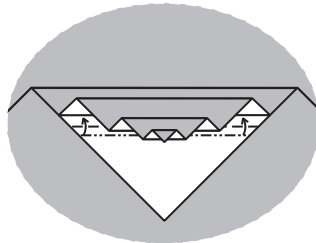

Pleat underneath.

20

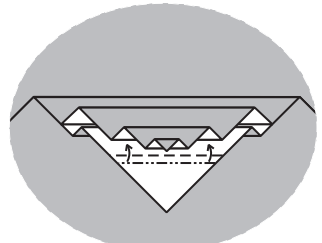

Pleat

21

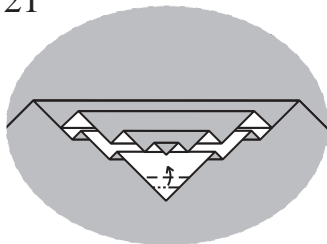

Pleat.

22

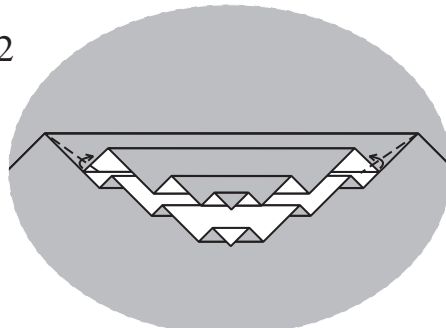

Valley-fold.

23

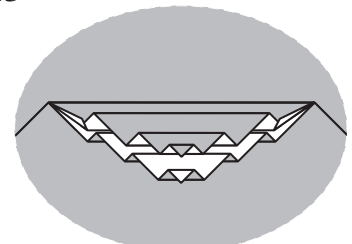

The smile is comPLEAT!

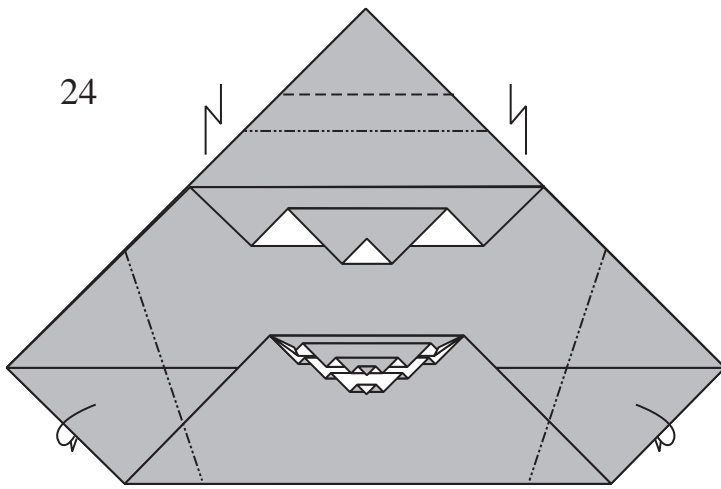

Pleat on top. Mountain-fold below.

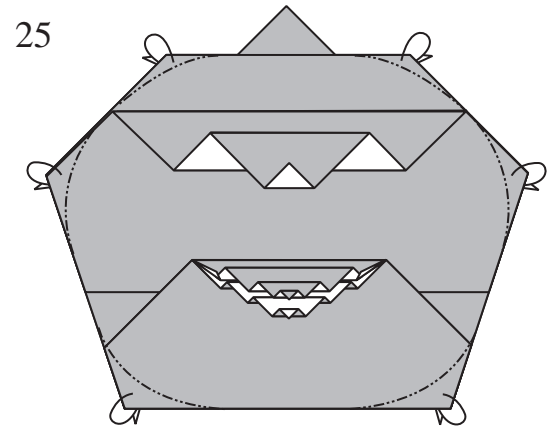

Round out the Jack-o-lantern to taste using mountain folds.

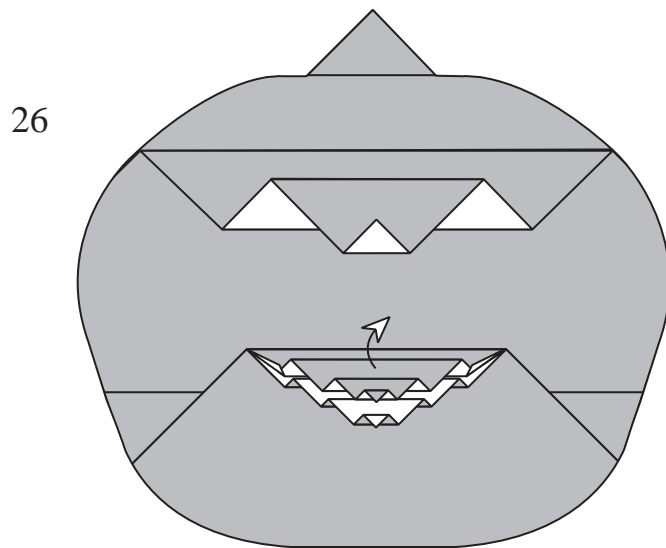

The Jack-o-Lantern is carved. To surprise it, swing up the top lip.

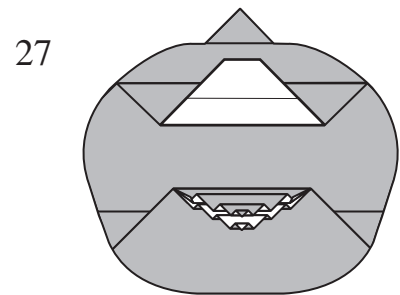

Psychlops!

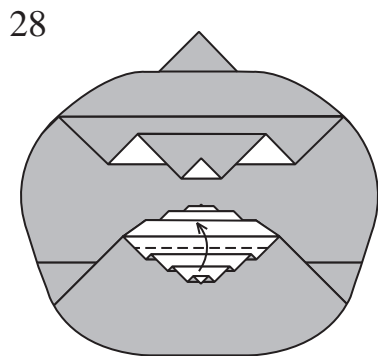

The Jack-o-Lantern is surprised. to make it mad, valley-fold up the bottom lip to taste.

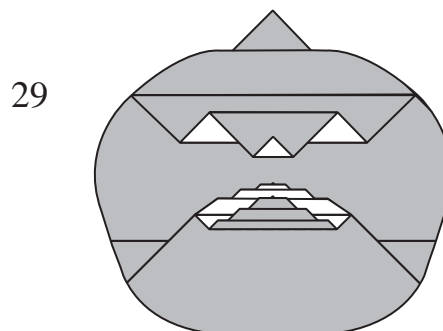

Using the rear flaps, see if you can make it stand on it's head.