

# Flower

By Kara Louie ©2004

Here's a bell flower that can also be used as a cup, or a hat or a cover for the Eiffel Tower.

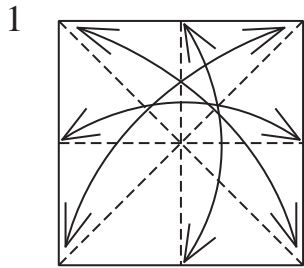
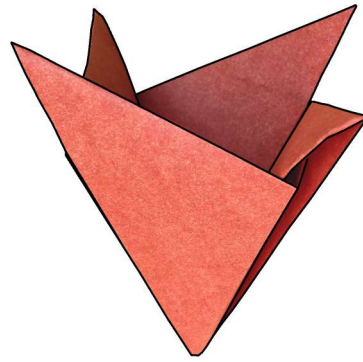

White side up, valley-fold and unfold in half every which way.

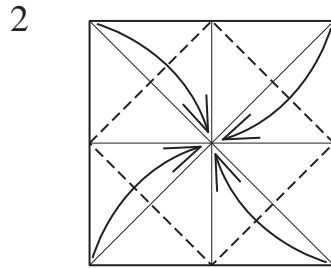

Blintz the four corners.

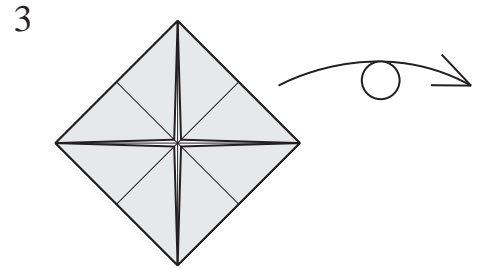

Turn the model over.

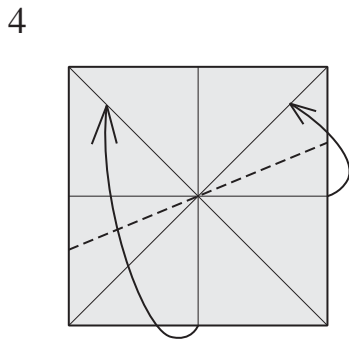

Valley-fold on the center point, crease-to-crease.

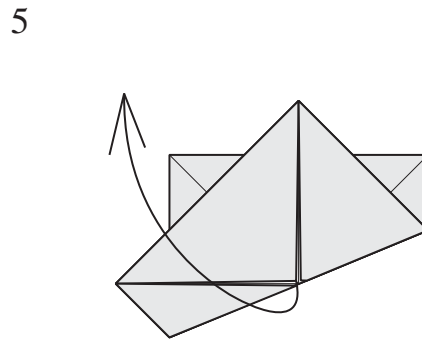

Unfold the flap.

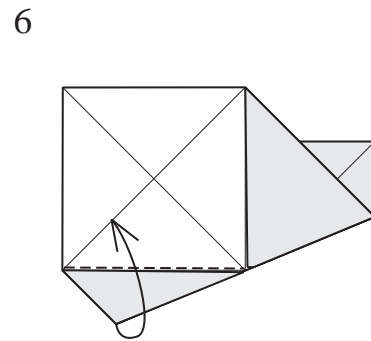

Valley-fold.

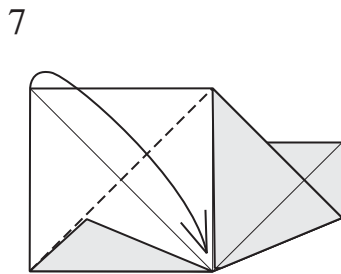

Valley-fold.

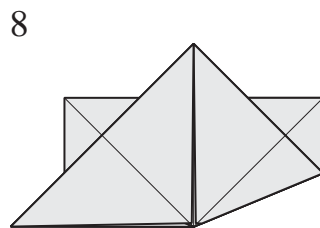

Turn over.

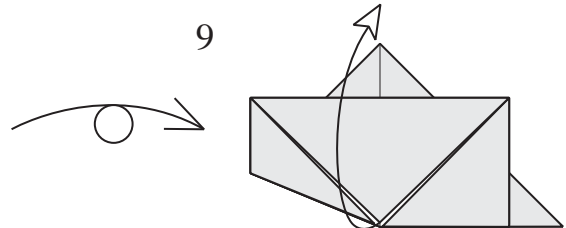

Unfold the flap.

10

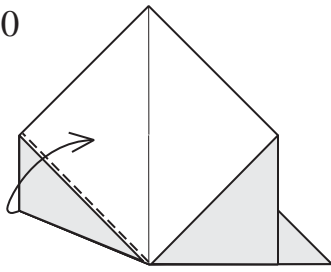

Valley-fold.

11

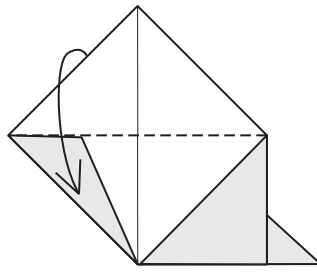

Valley-fold.

12

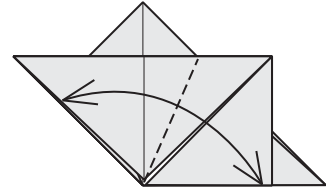

Valley-fold and unfold.

13

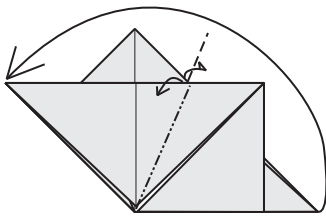

Open the pocket and squash the right-most corner to the left-most corner.

14

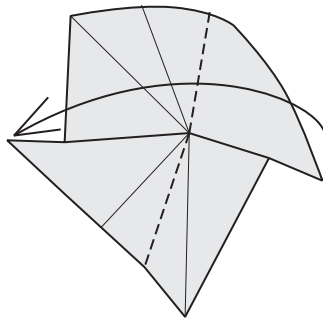
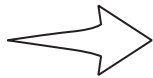

In progress.

15

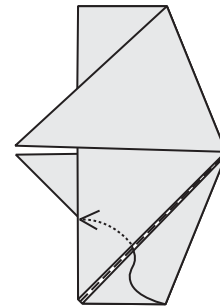

Valley-fold the flap, inserting it into the pocket. Rotate the model 90°.

16

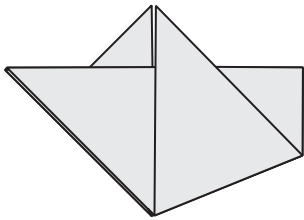

Turn over.

17

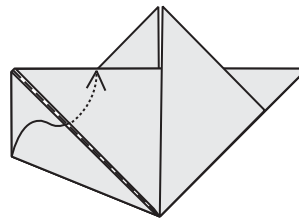

Valley-fold the flap, inserting it into the pocket.

18

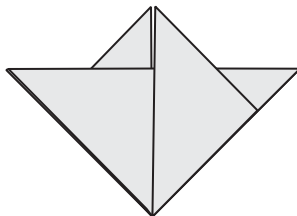

Open and you're done!

19

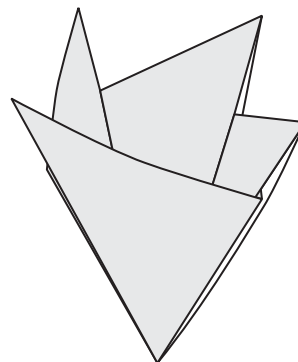

**The Flower is finished.** A pipe cleaner can be attached to give the flower a stem.

